

## Copyright

Copyright © 2021 by TOPDON TECHNOLOGY CO., LTD. All rights reserved. No part of this publication may be reproduced, stored, or transmitted in any form without the written permission of the copyright owner.

## Trademark

TOPDON is a registered trademark of TOPDON TECHNOLOGY CO., LTD in China and other countries. All other marks are trademarks or registered trademarks of their respective owners.

## Disclaimer

The contents of this document are subject to changes without notice due to continued improvements in design, manufacture, and methodologies. TOPDON is not liable for the damage or losses due to the use of this document.

## FCC Warning:

Any Changes or modifications not expressly approved by the party responsible for compliance could void the user's authority to operate the equipment. This device complies with part 15 of the FCC Rules. Operation is subject to the following two conditions:

- (1) This device may not cause harmful interference.
- (2) this device must accept any interference received, including interference that may cause undesired operation.

Note: This equipment has been tested and found to comply with the limits for a Class B digital device, pursuant to part 15 of the FCC Rules. These limits are designed to provide reasonable protection against harmful interference in a residential installation. This equipment generates uses and can radiate radio frequency energy and, if not installed and used in accordance with the instructions, may cause harmful interference to radio communications. However, there is no guarantee that interference will not occur in a particular installation. If this equipment does cause harmful interference to radio or television reception, which can be determined by turning the equipment off and on, the user is encouraged to try to correct the interference by one or more of the following measures:

- Reorient or relocate the receiving antenna.

- Increase the separation between the equipment and receiver.
- Connect the equipment into an outlet on a circuit different from that to which the receiver is connected.
- Consult the dealer or an experienced radio/TV technician for help.

The device has been evaluated to meet general RF exposure requirement. The device can be used in portable exposure condition without restriction.

**ISED Warning:**

This device contains licence-exempt transmitter(s)/receiver(s) that comply with Innovation, Science and Economic Development Canada's licence-exempt RSS(s). Operation is subject to the following two conditions:

- (1) This device may not cause interference.
- (2) This device must accept any interference, including interference that may cause undesired operation of the device.

L'émetteur/récepteur exempt de licence contenu dans le présent appareil est conforme aux

CNR d'Innovation, Sciences et Développement économique Canada applicables aux appareils radio exempts de licence. L'exploitation est autorisée aux deux conditions suivantes :


- 1) L'appareil ne doit pas produire de brouillage;
- 2) L'appareil doit accepter tout brouillage radioélectrique subi, même si le brouillage est susceptible d'en compromettre le fonctionnement.

This transmitter must not be co-located or operating in conjunction with any other antenna or transmitter. Cet émetteur ne doit pas être colocalisé ou fonctionner en conjonction avec une autre antenne ou un autre émetteur.

The device has been evaluated to meet general RF exposure requirement.




The device can be used in portable exposure condition without restriction.

Le matériel a été évalué pour répondre aux exigences générales d'exposition aux radiofréquences. Le dispositif peut être utilisé dans des conditions d'exposition portables illimitées.

 Important: Please read this manual carefully and understand the safety precautions before performing any operation to this product.

## Safety Grades

Safety grade definitions in this manual are as followings:

Symbol	Definition	Usage
	Danger	Indicates a hazardous situation which, if not avoided, will result in death or serious injury to the operator or to bystanders.
	Warning	Indicates a hazardous situation which, if not avoided, could result in possible injury to the operator or to bystanders.
	Caution	Indicates a hazardous situation which, if not avoided, could result in serious equipment damage or property losses.

## Safety Precautions

- Never collide, throw, or puncture the test equipment, and avoid falling, extruding and bending it.
- Do not insert foreign objects into or place heavy objects on your device. Sensitive components inside might cause damage.
- Do not use the test equipment in exceptionally cold or hot, dusty, damp or dry environments.
- In places using the test equipment may cause interference or generate a potential risk, please turn it off.
- The test equipment is a sealed unit. There are no end-user serviceable parts inside. All internal repairs must be done by an authorized repair facility or qualified technician. If there is any inquiry, please contact the dealer.
- Never place the test equipment into apparatus with strong electromagnetic field.
- Do not attempt to replace the internal rechargeable lithium battery. Contact the dealer for factory replacement.
- Use the included battery and charger. Risk of explosion if the battery is replaced with an incorrect type.

- Do not disconnect power abruptly when the test equipment is being formatted or in process of uploading or downloading. Or else it may result in program error.
- Do not disconnect battery or any wiring cables in the vehicle when the ignition switch is on, as this could avoid damage to the sensors or the ECU.
- Do not place any magnetic objects near the ECU. Disconnect the power supply to the ECU before performing any welding operations on the vehicle.
- Use extreme caution when performing any operations near the ECU or sensors. Ground yourself when you disassemble PROM, otherwise ECU and sensors can be damaged by static electricity.
- When reconnecting the ECU harness connector, be sure it is attached firmly, otherwise electronic elements, such as ICs inside the ECU, can be damaged.

### **Packing List**

The following packing list is for reference purpose only. For different destinations, the accessories may vary. For details, please consult from the local dealer or check the packing list supplied with this tool together.

- Main unit
- Power adaptor
- Main diagnostic cable
- The fourth-generation of EEPROM data acquisition cable (without dismantling dashboard)
- BENCH mode cable
- MCU converter V1
- MCU converter V2
- MCU cable with multiple leads
- EEPROM chip adaptor
- Benz infrared analog acquisition key
- MCU cable with multiple leads
- EEPROM converter
- User Manual

## Table of Contents

1 About this Manual .....	1
1.1 Target Reader .....	1
1.2 Typographic Conventions .....	1
1.3 Symbols .....	1
2 About T-Ninja Box .....	2
2.1 Product Overview .....	2
2.2 Power Source .....	3
2.3 Technical specifications .....	4
2.4 Accessories .....	4
3 Diagnostics .....	7
3.1 Common Operations .....	7
3.1.1 Establish Hardware Connection .....	7
3.1.2 Establish Wireless Connection .....	8
3.1.3 Perform Common Operations .....	8
3.2 Diagnostic Operations .....	9
3.2.1 Key Programming .....	9
3.2.2 Gear Box Programming .....	14
3.2.3 Engine Programming .....	18
4. Software Upgrade .....	25
5. Warranty .....	27

# 1 About this Manual

This manual introduces the basic information of T-Ninja Box and instruction on the product usage. T-Ninja Box is a powerful anti-theft solution and an ideal choice for professional repair shops and vehicle maintenance businesses. It has achieved vehicle key, Engine and gearbox programming, featuring powerful multiple parts reprogramming and wide range of vehicle coverage.

## 1.1 Target Reader

This document is intended for vehicle owners or repair technicians to perform various diagnostic procedures using T-Ninja Box; it assumes a basic knowledge of vehicles.



## 1.2 Typographic Conventions

The typographic elements that may be found in the document are defined in the following table:

Item	Presentation	Example
Cascading Menus	->	<b>T-Ninja Box-&gt;Local Diagnosis</b>
Parameter/value	<b>Bold</b>	Silde the WLAN switch to <b>“ON”</b> .
Variable/unfamiliar term	<i>Italic</i>	Visit us by <i>http://www.topdon.com</i>
UI control	<b>Bold</b>	On the <b>Health Check</b> screen, tap <b>Enter</b> .
Message	“”	The “success” message appears.

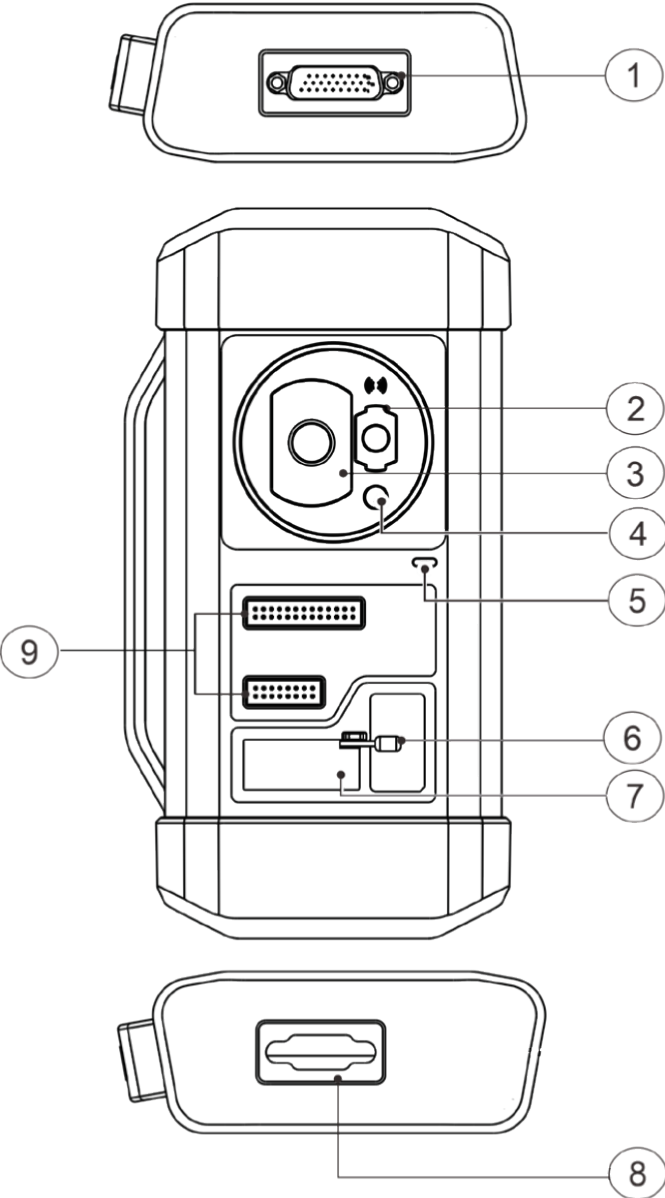
## 1.3 Symbols

Following symbols are used in this document:

Symbol	Definition	Usage
	Note	Widely used for any supplementary information.
	Tip	Refers to easily overlooked tricks that is necessary for a better user experience.

## 2 About T-Ninja Box

### 2.1 Product Overview



No.	Part Name	Description
1	DB26 diagnostic connector	To connect with all anti-theft cables.
2	Benz key slot	To place Benz car key.
3	Key slot	To place car key for RF defection.
4	Key chip slot	To place key chip.
5	Power indicator	<ul style="list-style-type: none"> <li>• Red light indicates faults.</li> <li>• Orange light indicates normal operation.</li> </ul>
6	Valve	To tighten loose EEPROM board.
7	EEPROM slot	To insert EEPROM board
8	DB15 diagnostic connector	To connect with main diagnostic cable.
9	DIY slot	To insert vehicle DIY board.

## 2.2 Technical Specifications

Input voltage	DC 12V
Input current	500 mA
Working temperature	0 to 50 °C
Storage temperature	- 20 to 70 °C
Dimension	39 x 107 x 298 mm



## 2.3 Power Source

The product does not have an independent power supply, you can power it up via either of the followings ways:

- Use the included power adaptor
- Connect the device through the vehicle's DLC

## 2.4 Accessories

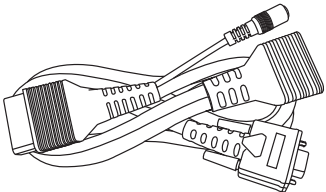
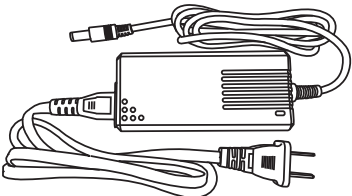
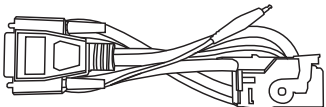
Photo	Accessory Name	Description
	Main diagnostic cable	To connect vehicle DLC port, VCI and programmer for diagnosis.
	Power adaptor	To provide power supply for the programmer.
	The fourth generation of EEPROM data acquisition cable (without dismantling dashboard)	Connect the programmer and vehicle dashboard, and then place the probe (the yellow lead) to the designated area.

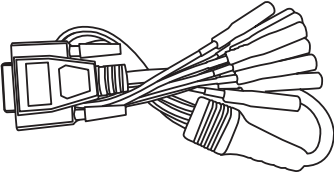
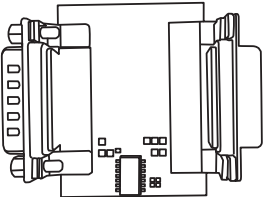
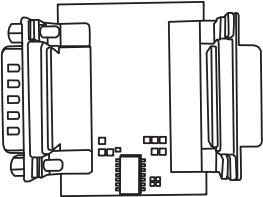
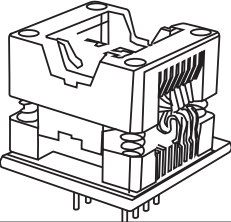
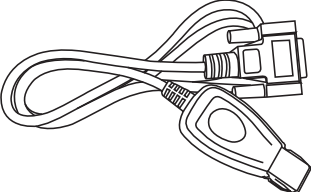
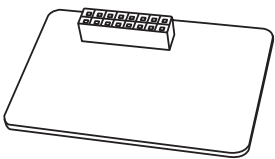

Photo	Accessory Name	Description
	<p>BENCH mode cable</p>	<p>Connect the programmer and the engine to read engine or gearbox ECU (Connect engine ECU with the BENCH mode cable based on BENCH mode diagram).</p>
	<p>MCU Converter V1</p>	<p>Connect the programmer with MCU(chip soldering is required in this procedure).</p>
	<p>MCU Converter V2</p>	<p>Connect the programmer with MCU(chip soldering is required in this procedure).</p>
	<p>EEPROM chip adaptor</p>	<p>Place the EEPROM chip onto the adaptor, and then plug it into the programmer socket.</p>
	<p>Benz infrared analog acquisition key</p>	<p>To connect the programmer with the key lock, insert the key into the programmer for further key operations.</p>

Photo	Accessory Name	Description
 A small, rectangular printed circuit board (PCB) with a single integrated circuit (chip) mounted on its surface. The chip is a square component with a grid of pins on its top edge.	EEPROM converter	Solder the desired chip on the EEPROM converter, and then plug the board into the programmer(chip soldering is required)
 A cable with a multi-pin connector on one end and a bundle of many individual wires on the other. The connector is a rectangular plastic housing with several pins protruding from it.	MCU cable with multiple leads	To connect the programmer and MCU.

### 3 Diagnostics

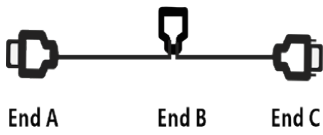

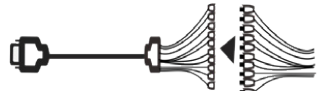
T-Ninja Box diagnostic function supports key programming, engine and gear-box replacement for various of vehicles, you can retrieve ECU information, read, erase, and write in for a range of chips as shown in the product options.

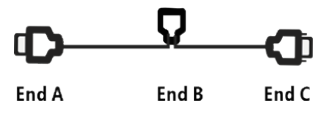
#### 3.1 Common Operations

- **3.1.1 Establish Hardware Connection**

You need to turn off the ignition and correctly locate the vehicle Data Link Connector (DLC) so as to perform hardware connection.


You can refer to the table below for hardware connection:


User Scenario	Cable Image	End A	End B	End C
Key programming	 <p>End A                  End B                  End C</p> <p>Main diagnostic cable</p>	Connect with TOPDON VCI connector for data transmission	Connect with vehicle's DLC	Connect with T-Ninja Box
Engine/ Gearbox programming	 <p>End A                  End B                  End C</p> <p>Power cable</p>	Connect to power supply	N/A	Connect to end B of the main diagnostic cable
Engine/ Gearbox programming	 <p>End A                  End B</p> <p>MCU cable with multiple leads</p>	Connect with T-Ninja Box	Connect with the engine or gearbox to be repaired/replaced	N/A

<p>Engine/ Gearbox programming</p>	 <p>End A      End B      End C</p> <p>Main diagnostic cable</p>	<p>Connect with TOPDON VCI connector for data transmission</p>	<p>Connect to power supply cable</p>	<p>Connect with T-Ninja Box</p>
--	---	--	--	-------------------------------------

### • 3.1.2 Establish Wireless Connection

You must make sure that your diagnostic tool is well connected with T-Ninja Box, and follow steps below to check wireless connection:

 **Note:** It is strongly recommended to connect the diagnostic tool with the VCI connector using a USB cable for effective data transmission.

1. Slide down the status bar from the top.
2. Tap , go to **Wireless and network -> Bluetooth**.
3. Select the T-Ninja Box to be connected, wait until the connection is successful.

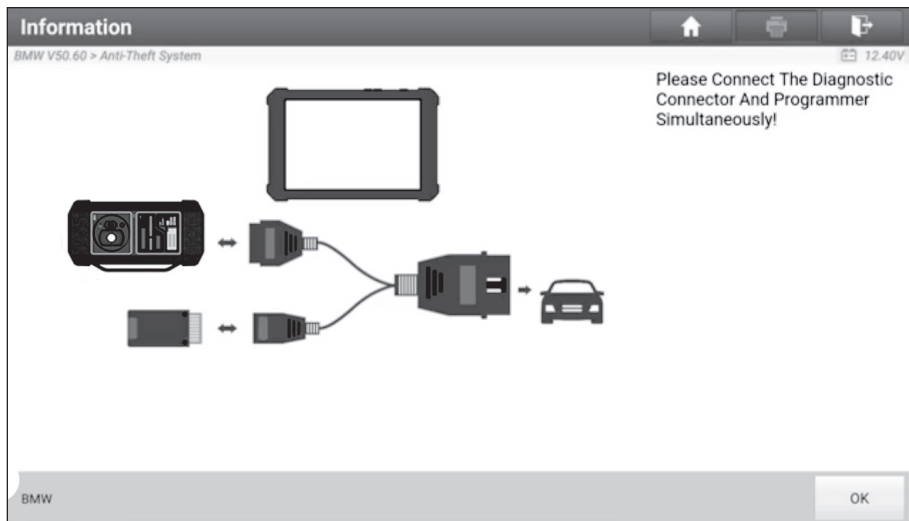
### • 3.1.3 Perform Common Operations

You should enter the function interface before using the programmer.

1. Turn on a TOPDON diagnostic tool, and/or open the diagnostic App on the home screen.
2. On the main diagnostic screen, enter Anti-theft system either from **Local Diagnose** or **Reset**, tap **OK**.



3. You will view the connection diagram, tap **OK**.



4. Depending on your requirement, select any of the following options :
- Gearbox Learning
  - Anti-Theft System
  - Engine System

## 3.2 Diagnostic Operations

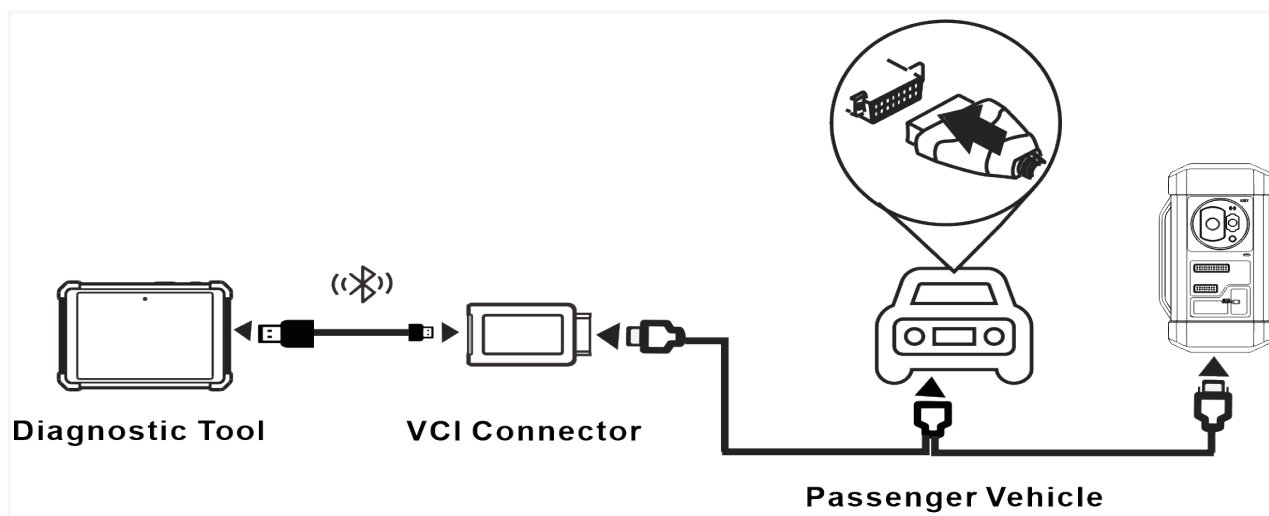
### • 3.2.1 Key Programming

You can use anti-theft system to access key chip programming functions. The product supports reading, retrieving and writing key information, as well as other key-related functions.

#### • Set up the Connections

#### Note:

The USB cable shown in the following diagram is not included in the packing list for now, nevertheless, using a USB cable could effectively enhance your data transmission speed.

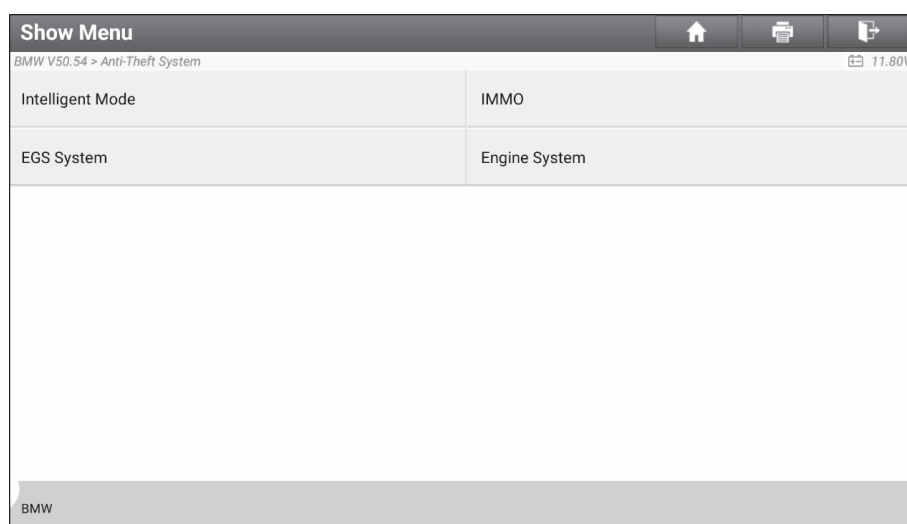


- **Operating on key programming**

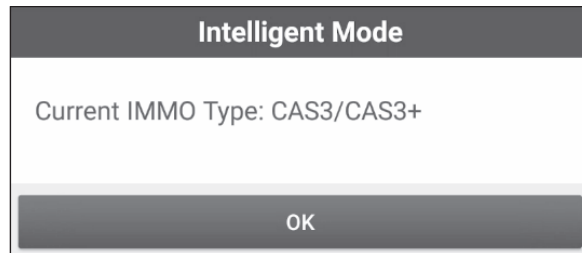
You can use key programming function to backup old key data and write in data for new keys. Below procedure shows you how to perform key programming for BMW using TOPDON diagnostic product. It contains backup current key data and new key generation.

1. Backup current key data.

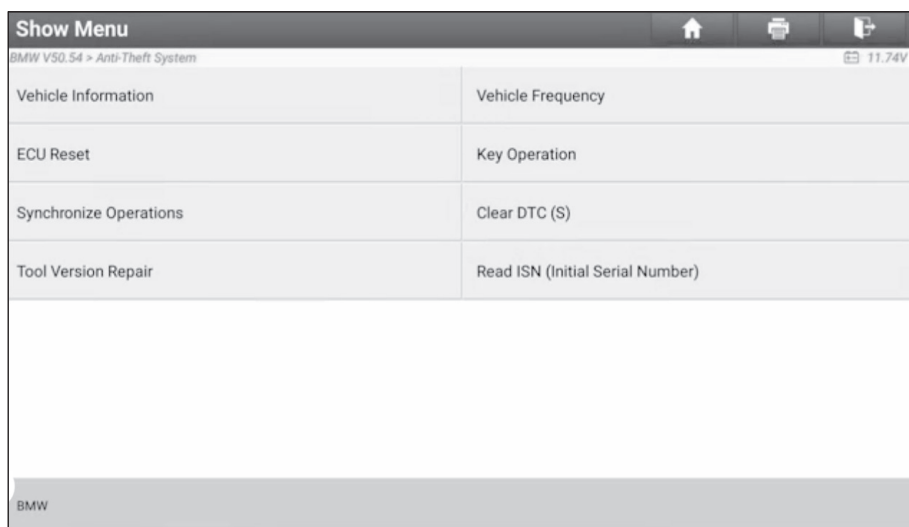
a. **Select Intelligent Mode.**



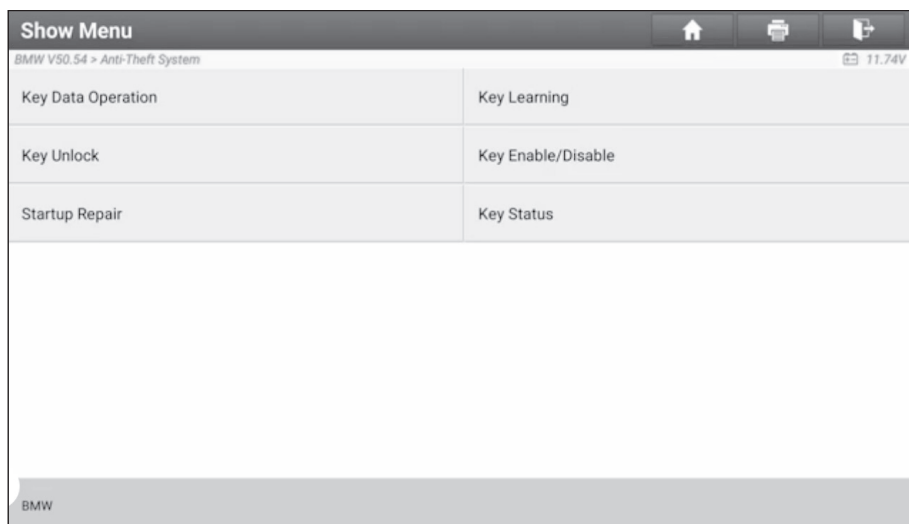
b. Tap **OK** to confirm the IMMO Type.



c. Select **Key Operation**.

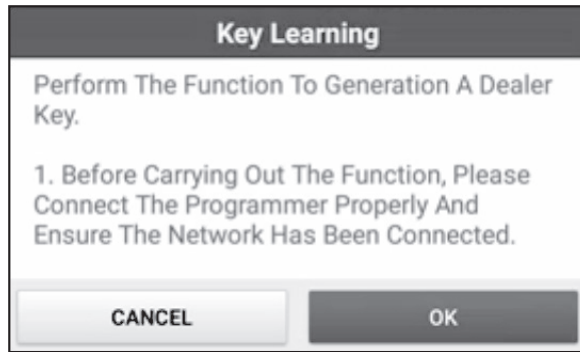


d. Select **Key Learning**.

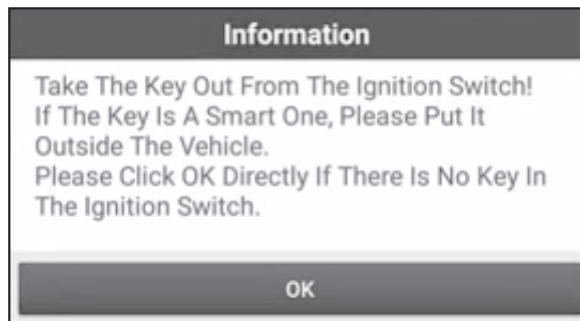


e. Tap **OK** after reading the onscreen instruction.

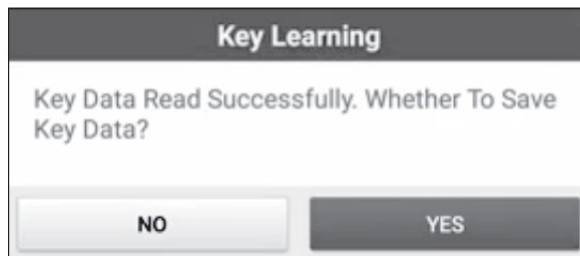




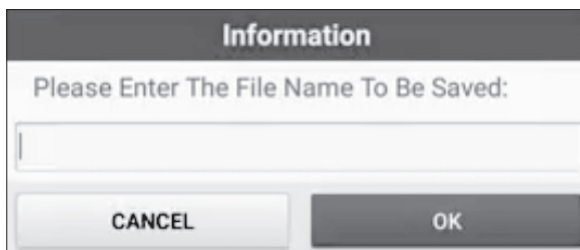
f. Tap **OK**.



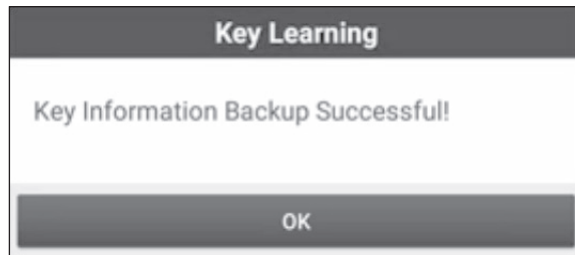
g. Tap **OK** to save the key data.



h. Enter the key file name and tap **OK**.



i. Key file saved, tap **OK** to confirm.



2. Generate a new key.

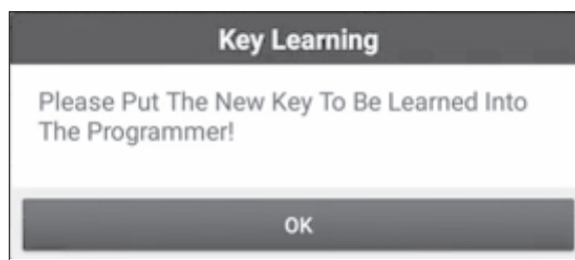
a. Select the desired blank key position.

A screenshot of the 'Key Learning' application interface showing a table of key information. The title bar reads 'Key Learning'. Below the title bar, there is a navigation bar with a home icon, a printer icon, and a share icon. The main content area displays a table with the following data:

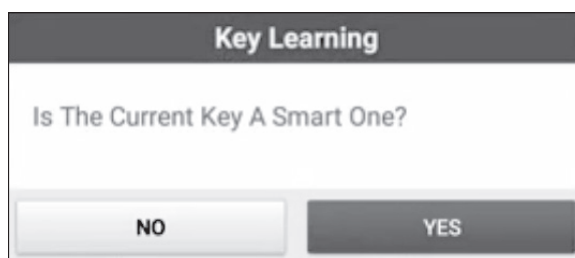
Key Position	Key ID	Key Type	Key Status	Vehicle Information	Enable/Disable Status
Key 2	BB53EE90	PCF 7953 remote key	Used	014B00	Disable
Key 3	1454EE90	PCF 7953 remote key	Used	004B00	Enable
Key 4	47AE9896	PCF 7953 remote key	Used	004300	Enable
Key 5	9C03869E	PCF 7953 remote key	Used	004300	Enable
Key 6	FFFFFFFF	Unknown	Unused	007608	Enable
Key 7	FFFFFFFF	Unknown	Unused	007608	Enable
Key 8	FFFFFFFF	Unknown	Unused	007608	Enable

Below the table, there are three buttons: 'Key Generated By Ignition Switch', 'Key Generated By Programmer', and 'Erase Key 1'. At the bottom left, there is a 'BMW' logo.

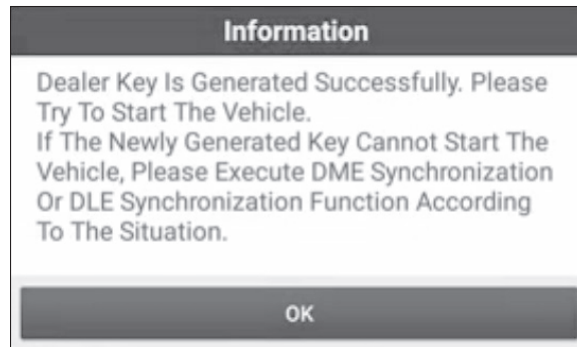
b. Place the new key into the programmer key slot and tap **OK**.



c. Confirm the key type. If the you are using a smart key, tap **YES**.



d. If the key generation is done, tap **OK** to confirm.



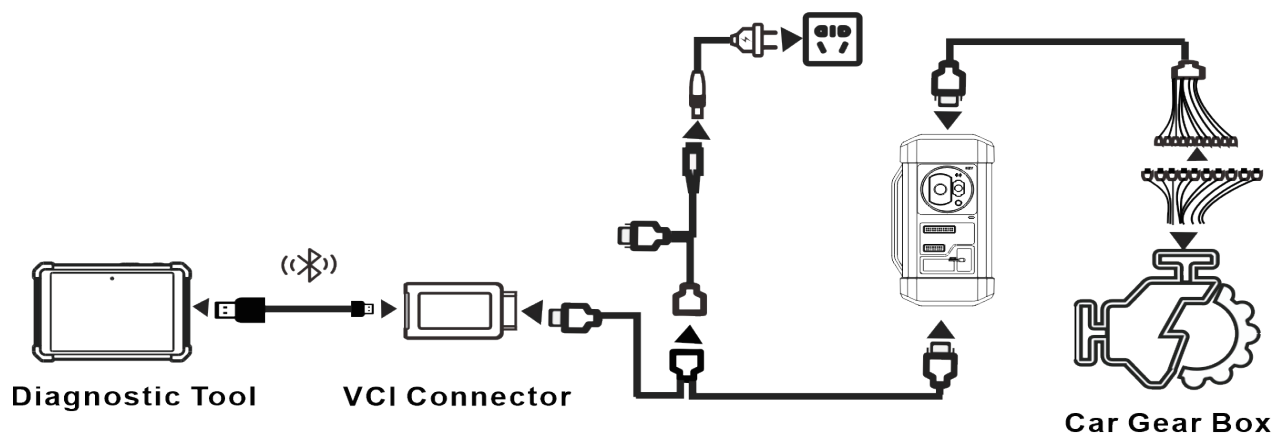
### • 3.2.2 Gearbox Programming

You can use gearbox programming function to restore the old gearbox data or write in new data after a new gearbox is replaced.

#### • Set up the Connections for Gearbox Programming

##### Note:

- The USB cable shown in the following diagram is not included in the packing list for now, nevertheless, using a USB cable could effectively enhance your data transmission speed.
- Certain vehicle gearboxes are connected based on the real chassis type. For information on how to connect to a gearbox, refer to the *onscreen connection diagram*

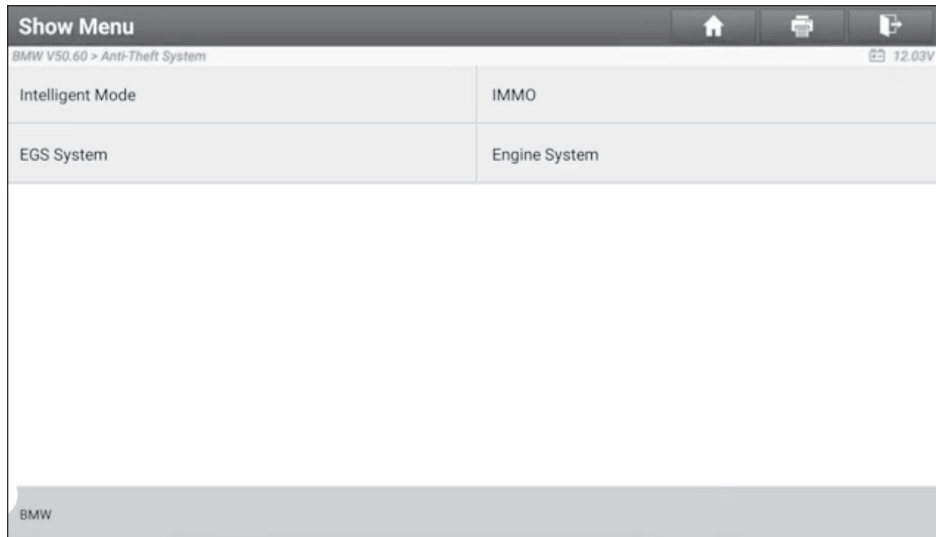


#### • Operating on gearbox programming

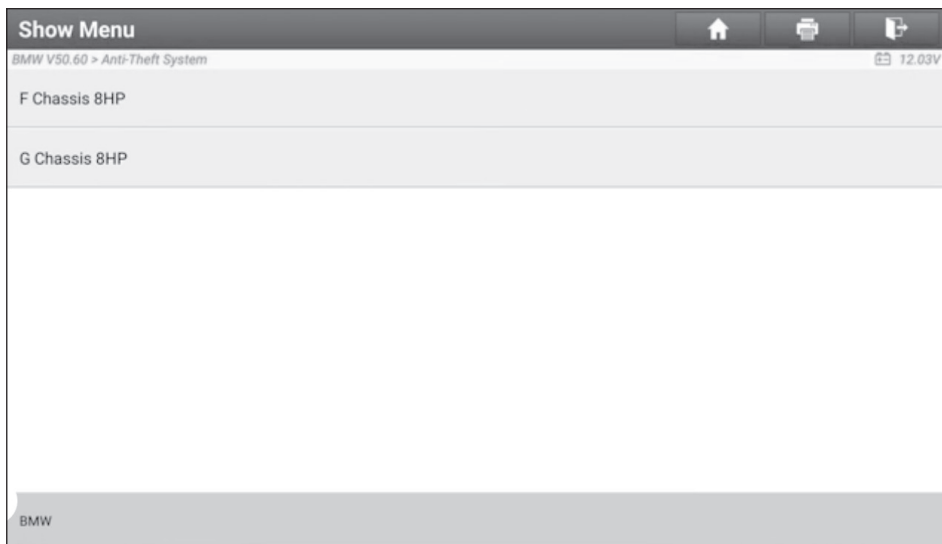
The following procedure shows you how to perform gearbox programming for a BMW using TOPDON diagnostic product, which contains gearbox connection and erasure of gearbox data.

1. Connecting to the gearbox.

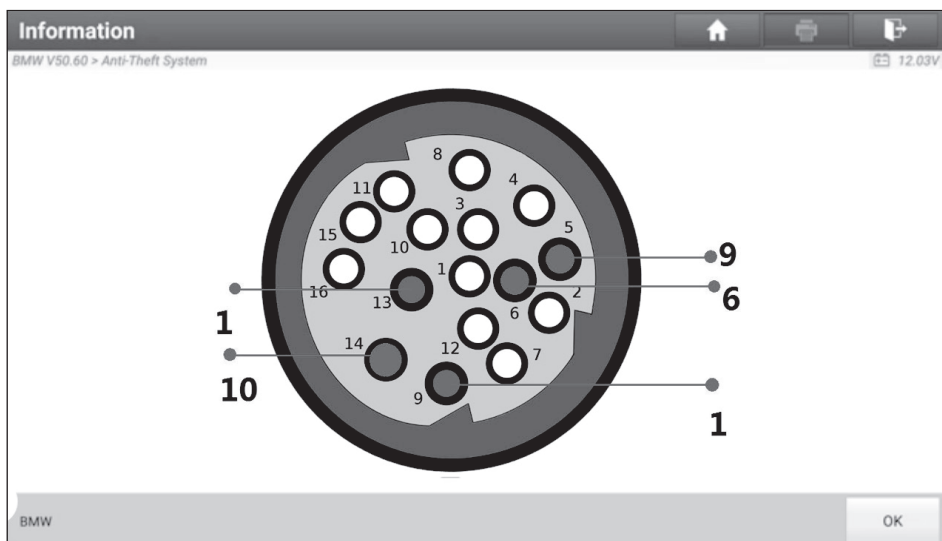
- a. On the programmer function interface, select **EGS System** to enter gear-box programming.



- b. Select the correct chassis type.

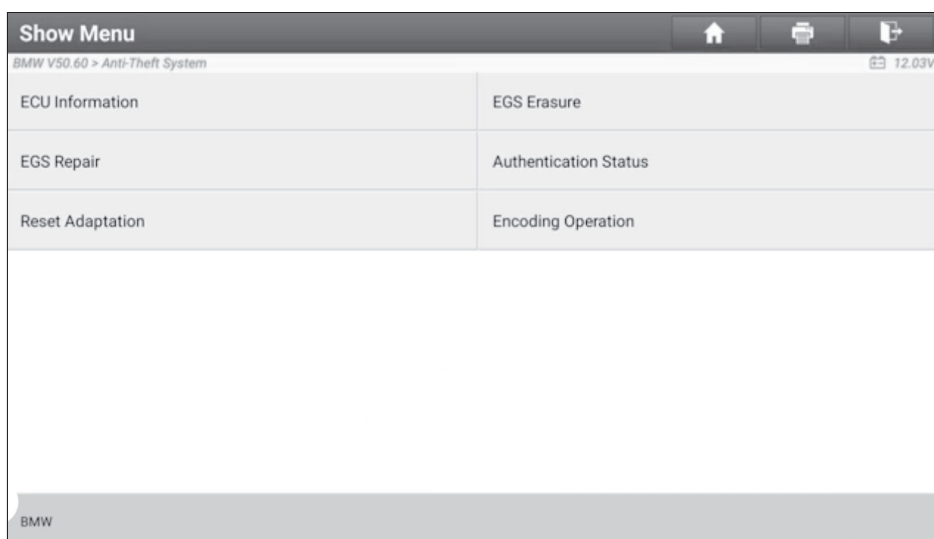


- c. You will then see a corresponding connection diagram. Tap **OK**.

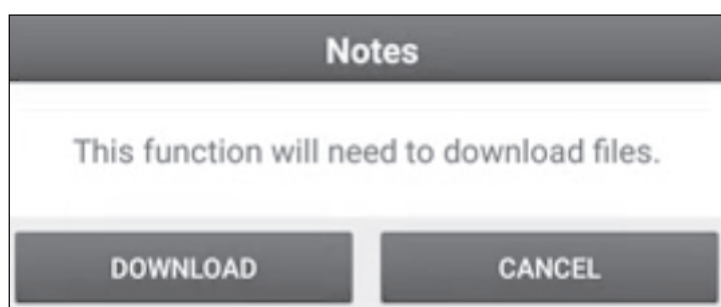


2. Erasing gearbox data.

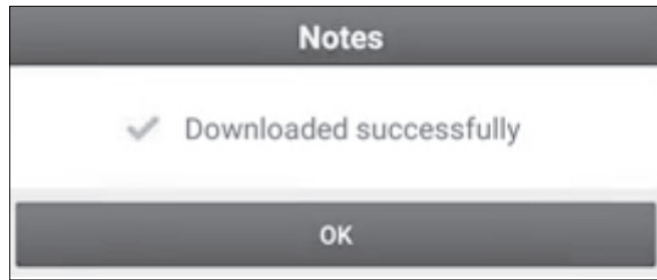
a. Select **EGS Erasure**.



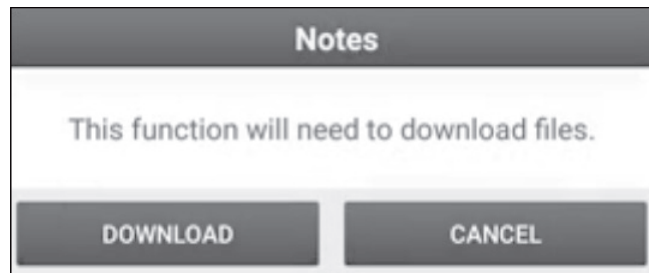
b. Tap **DOWNLOAD**.



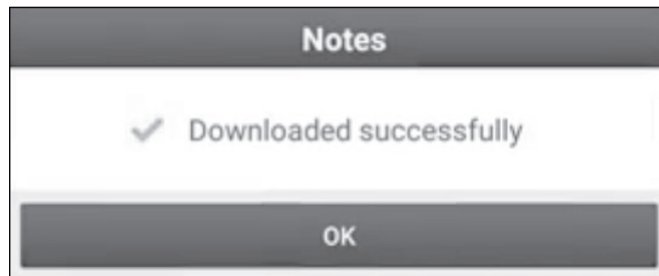
c. Tap **OK**.



d. Tap **DOWNLOAD**.



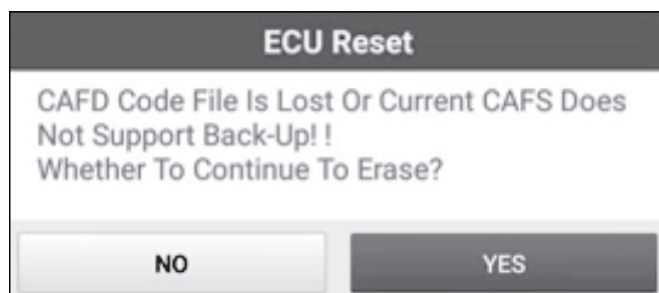
e. Tap **OK**.



f. Tap **YES**.



g. Tap **YES**.



h. Tap **OK**.



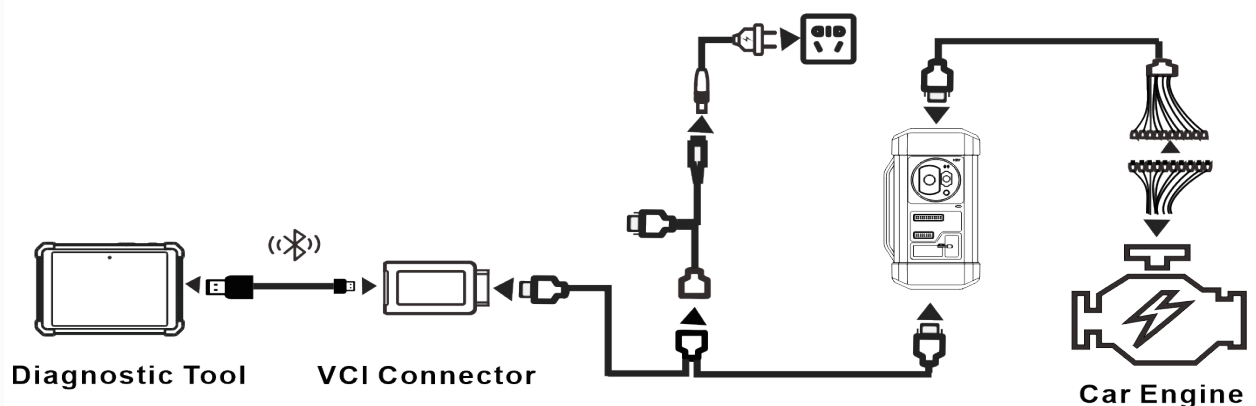
### • 3.2.3 Engine Programming

The engine programming function supports engine data reading. After a new gearbox is replaced, you can use engine programming function to write in the backup data.

#### • Set up the Connections for Engine Programming

 Note:

- The USB cable shown in the following diagram is not included in the packing list for now, nevertheless, using a USB cable could effectively enhance your data transmission speed.
- Vehicle engine connection could vary depending on engine types. For information on how to connect to a car engine, refer to the on-screen connection diagram.



#### • Operating on Engine Programming

The following procedure shows you how to perform engine programming for a Volkswagen using TOPDON diagnostic product, which contains

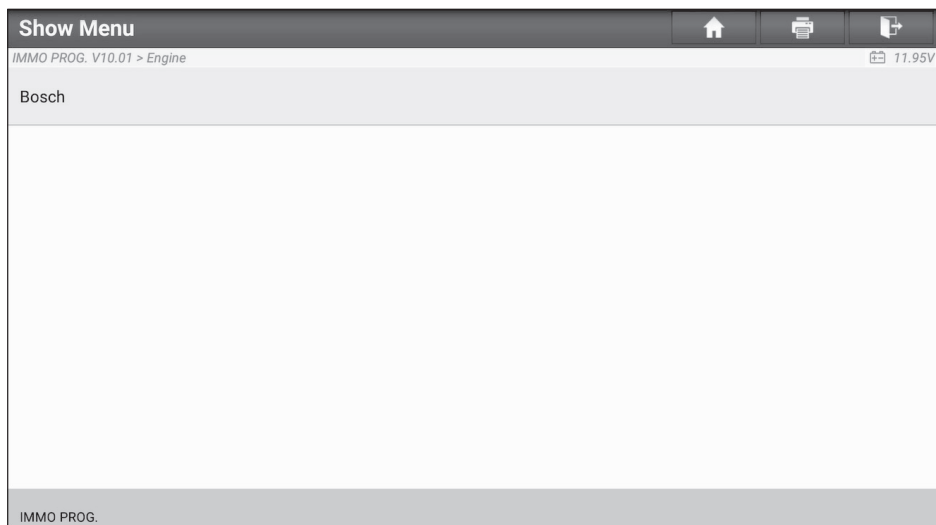
chip ID retrieval, engine connection, data backup and data restoration.

1. Retrieve chip ID.

a. Tap **Engine**.

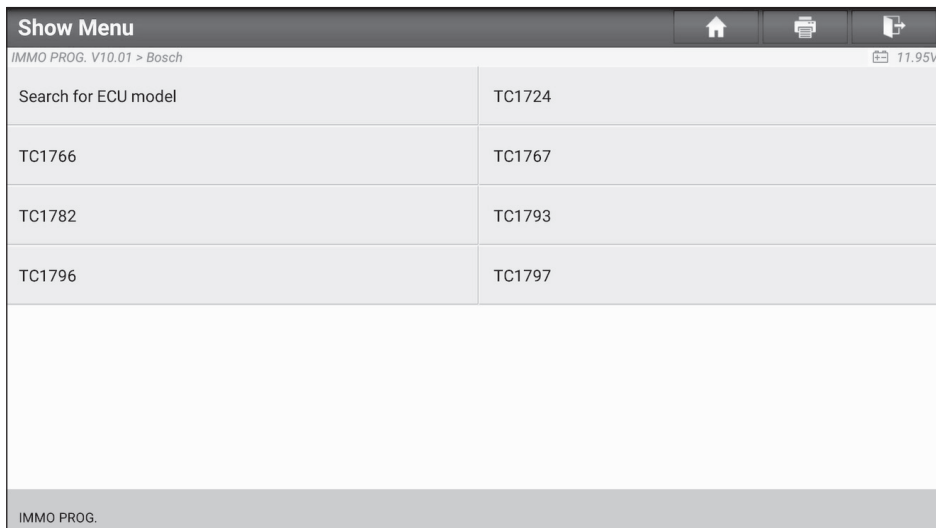


b. Select Engine Brand.

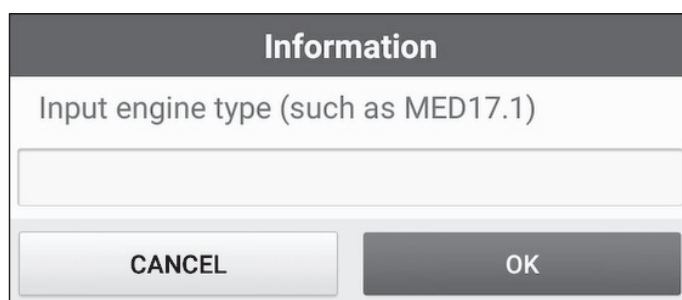


c. Select **Search for ECU model**.

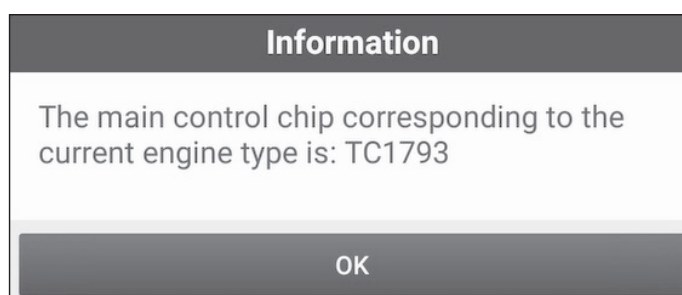




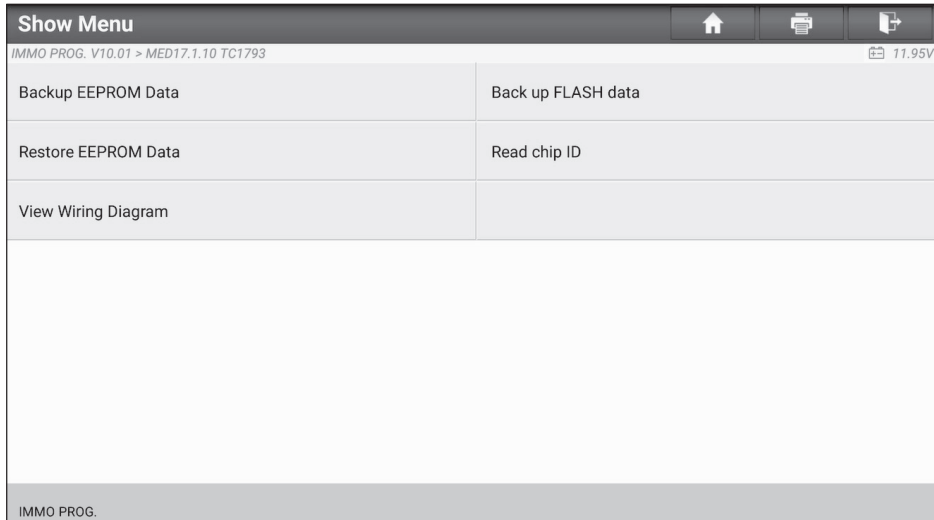
- d. Check ECU model (printed on the sticker on the back of your Engine), enter the engine type in the dialogue box (Take the following picture as an example, the engine type should be MED17.7.7).



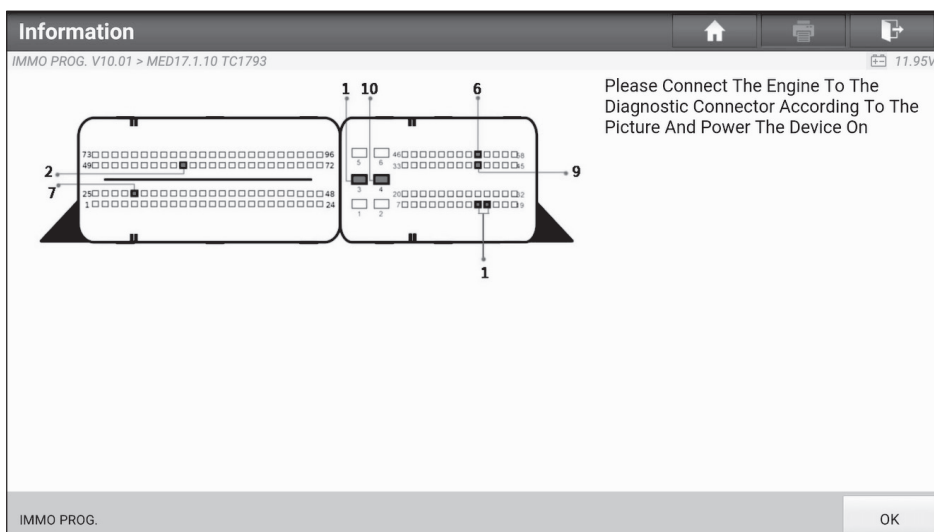
- e. Tap **OK**.



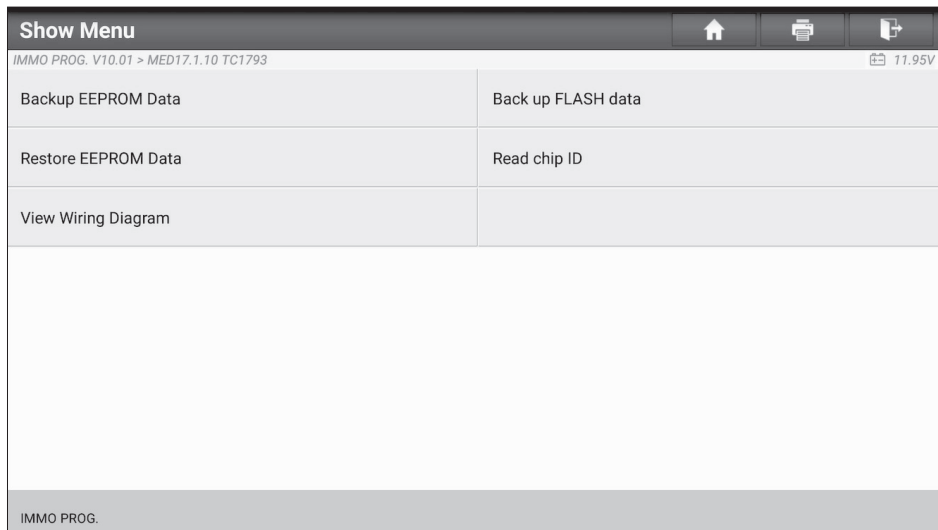
2. Connect to an engine.
  - a. Select View Wiring Diagram.



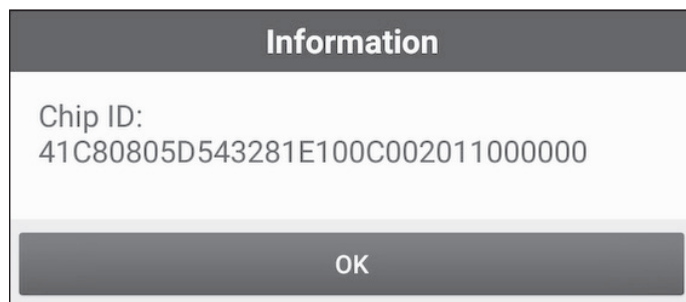
- b. Read the connection diagram, perform the proper connection based on the engine type and then tap **OK**.



- c. Select **Read chip ID**.

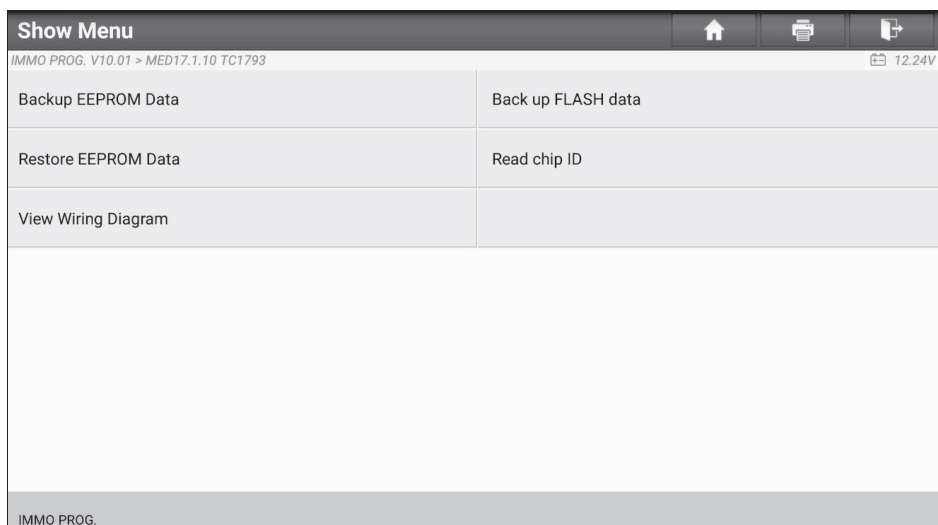


d. When the following dialogue box appears, tap **OK**.

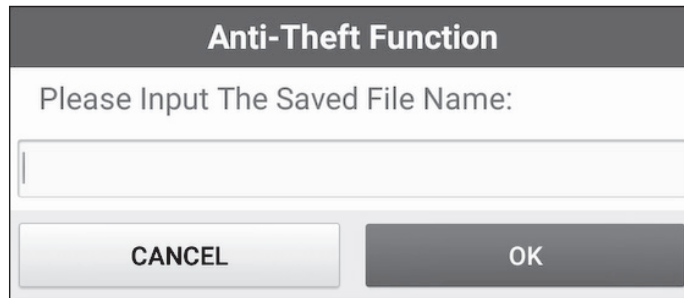


3. Backup data.

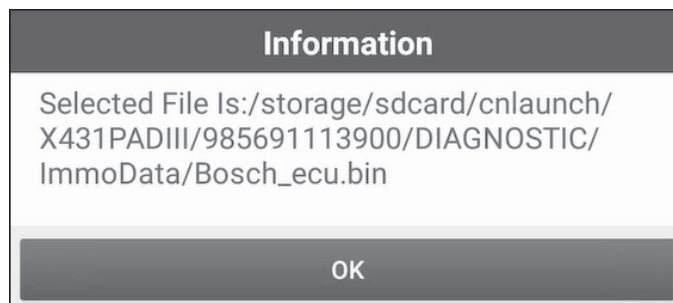
a. Select **Backup EEPROM Data**.



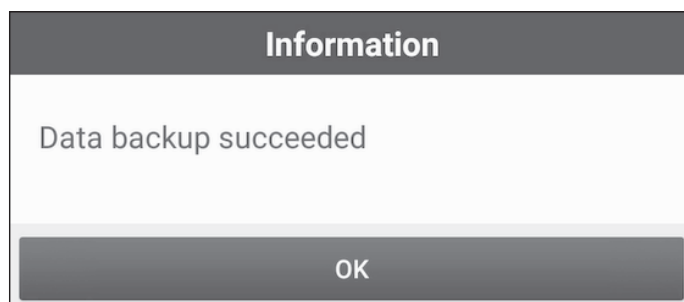
b. Enter the file name for EEPROM data.



c. Confirm the storage path, and tap **OK**.




d. Tap **OK**.



e. Follow the onscreen instructions to backup flash data.

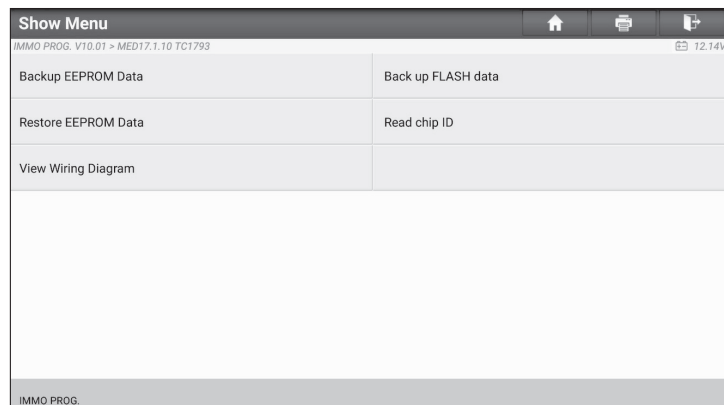
4. Restore EEPROM data.

---

 **Tip:** Use EEPROM restoration only if you encounter an irreversible error.

---

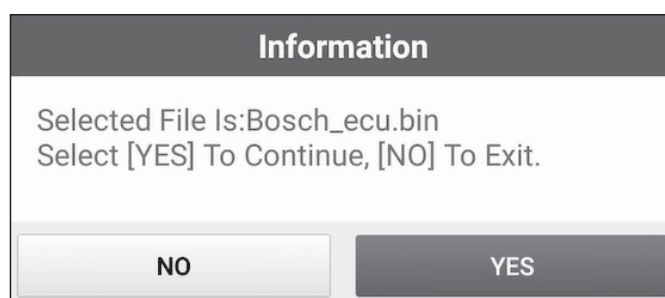
a. Select Restore EEPROM Data.



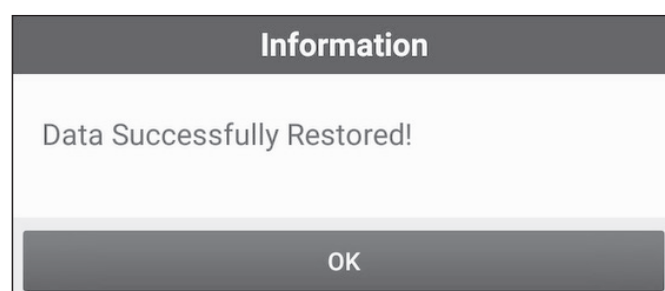
b. Select Backup EEPROM file name.



c. Confirm the selected Backup EEPROM file, and tap **OK**.



d. When the data is successfully restored, tap **OK**.

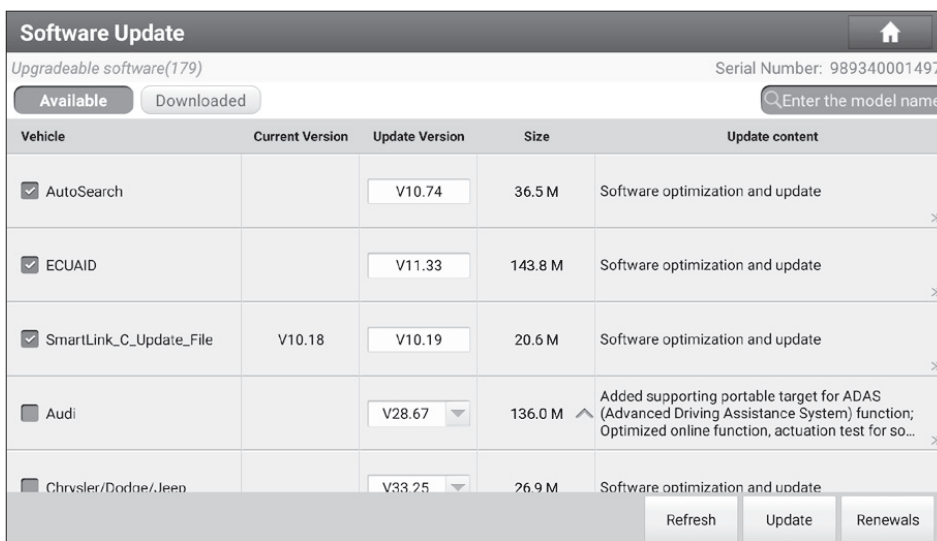


## 4. Software Upgrade

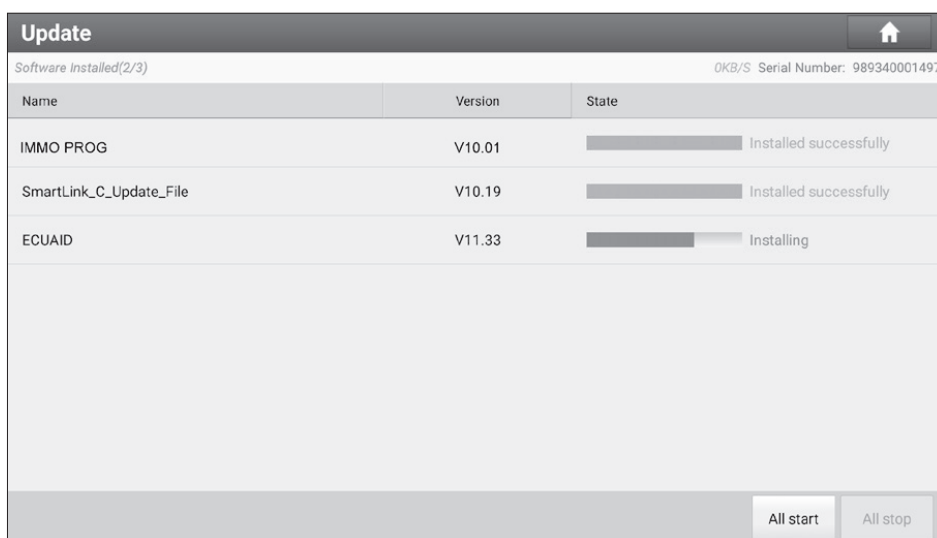
The software update function keeps your diagnostic software & App up-to-date. You can also use it to customize your frequently used software.

To update Diagnostic Software & APP:

1. On the main diagnostic screen, tap **Software Update** to enter the update center. Check the software you want to upgrade, and then tap **Update**.



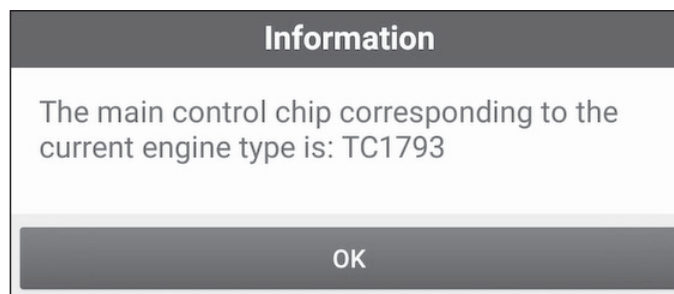
2. Once downloading completes, the software packages will be installed automatically.



 Note:

- You can stop the process by tapping **Stop**, and tap **Continue** to resume the process later.
- In case of network connection failure, tap **Retry**.

3. You will see the following dialogue box once the installation is completed.



## 5. Warranty

### TOPDON One Year Limited Warranty

TOPDON warrants to its original purchaser that TOPDON products will be free from defects in material and workmanship for 12 months from the date of purchase (Warranty Period). For the defects reported during the Warranty Period, TOPDON will, according to its technical support analysis and confirmation, either repair or replace the defective part or product.

This limited warranty is void under the following conditions:

Misused, disassembled, altered or repaired by unauthorized stores or technicians.

Careless handling and violation of operation.

Some countries, states and provinces do not allow the exclusion or limitation of incidental or consequential damages or exclusions or limitations on the duration of implied warranties or conditions, so the above limitations or exclusions may not apply to you.

[www.rptoolsitaliastore.com](http://www.rptoolsitaliastore.com) [info@rptoolsitaliastore.com](mailto:info@rptoolsitaliastore.com) facebook:

[www.facebook.com/rptoolsitalia.it](http://www.facebook.com/rptoolsitalia.it)

Via Predda Niedda str 11, n 14 07100 Sassari

Contatti e info:

+ 39 3491149384

+ 39 3514120848

